

Stoichiometric Constraints on Resource Use, Competitive Interactions, and Elemental Cycling in Microbial Decomposers

Mehdi Cherif^{1,*} and Michel Loreau^{2,†}

1. Biogéochimie et Ecologie des Milieux Continentaux Laboratory, Unité Mixte de Recherche 7618, Ecole Normale Supérieure, 46 rue d'Ulm, F-75230 Paris Cedex 05, France;

2. Department of Biology, McGill University, 1205 avenue Docteur Penfield, Montreal, Quebec H3A 1B1, Canada

Submitted February 8, 2006; Accepted January 2, 2007;
Electronically published April 6, 2007

Online enhancements: appendixes.

ABSTRACT: Heterotrophic microbial decomposers, such as bacteria and fungi, immobilize or mineralize inorganic elements, depending on their elemental composition and that of their organic resource. This fact has major implications for their interactions with other consumers of inorganic elements. We combine the stoichiometric and resource-ratio approaches in a model describing the use by decomposers of an organic and an inorganic resource containing the same essential element, to study its consequences on decomposer interactions and their role in elemental cycling. Our model considers the elemental composition of organic matter and the principle of its homeostasis explicitly. New predictions emerge, in particular, (1) stoichiometric constraints generate a trade-off between the R^* values of decomposers for the two resources; (2) they create favorable conditions for the coexistence of decomposers limited by different resources and with different elemental demands; (3) however, combined with conditions on species-specific equilibrium limitation, they draw decomposers toward colimitation by the organic and inorganic resources on an evolutionary time scale. Moreover, we derive the conditions under which decomposers switch from consumption to excretion of the inorganic resource. We expect our predictions to be useful in explaining the community structure of decomposers and their interactions with other consumers of inorganic resources, particularly primary producers.

Keywords: stoichiometry, mineralization, immobilization, resource-ratio theory, competition.

Heterotrophic microbial decomposers, such as bacteria and fungi, are key components of ecosystems because they play a major role in the processing of plant detritus, which is the fate of the majority of primary production (Cebrián 1999). Despite their importance in elemental cycling, decomposers have long been studied as a black box about which little was known regarding its internal structure and dynamics (Tiedje et al. 1999). The explanation for this state of affairs lies at least partly in the technical difficulties of separating microbial organisms from their surrounding environment, because of their small size and their intricate link to their substrate, and of culturing the most ecologically relevant strains in vitro. Because of these methodological handicaps, parameters and patterns relevant to modeling interactions among decomposers, or between decomposers and other trophic levels, are scarcely known. In recent years, however, technological advances have made it possible to open the black box and to start studying decomposers as a community shaped by the specific properties of its members and by their interactions with each other and their surroundings (Tiedje et al. 1999; Leckie 2005). Somewhat paradoxically, these new techniques are generating a wealth of data that are critically in need of a theoretical framework that allows an understanding of the relationship between decomposer community structure and the role of decomposers in ecosystem functioning (Andrén and Balandreau 1999).

A successful approach that has been used previously to understand and predict community attributes in other organisms is the resource-ratio theory (MacArthur 1972; Tilman 1980). This theory offered a fruitful method for linking the properties of phytoplankton species to processes among them and to other trophic levels (Tilman 1980; Daufresne and Loreau 2001*b*; Grover 2002). The parameter R^* , the minimum requirement of a phytoplankton species for a given resource at equilibrium, is a central

* Corresponding author. Present address: Department of Biology, McGill University, 1205 avenue Docteur Penfield, Montreal, Quebec H3A 1B1, Canada; e-mail: cherif@biologie.ens.fr.

† E-mail: michel.loreau@mcgill.ca.

parameter in this theory. Determining this parameter for the various resources and species involved allows one to predict which species will persist under given resource supplies and which species will replace others along a resource gradient (Tilman 1980). Microbial decomposers share with plants the ability to assimilate elements that are essential to their growth, such as nitrogen and phosphorus, in inorganic form. Simple species-specific parameters like R^* would therefore be useful in explaining competitive interactions of decomposers and ecosystem-level elemental fluxes. But decomposers differ from primary producers in their requirement of an organic source of carbon, because they cannot fix CO_2 , and in their ability to retain the essential elements other than carbon contained in this organic resource. Application of the resource-ratio theory to organisms that have this ability to use alternative resources that bind together essential elements in different ratios may bring interesting new insights and conclusions, even though the theory was developed mainly for the study of organisms that use separate essential resources.

Ecological stoichiometry provides another approach to understanding the use of resources by decomposers. Ecological stoichiometry characterizes the relative growth requirements of decomposers for the various essential elements and compares them to the relative quantities of these elements in their resources. The assimilation of the various resources is constrained in such a way that both mass balance and homeostasis of elemental composition are satisfied (Goldman and Dennett 1991; Sterner and Elser 2002). Because of these homeostatic stoichiometric constraints, inorganic elements can be either taken up (immobilized) or excreted (mineralized) by decomposers, depending on whether the quantity of the elements contained in the organic resources is deficient or exceeds the requirements of decomposers (Goldman and Dennett 2000; Daufresne and Loreau 2001a).

In this work, we combine the stoichiometric and resource-ratio approaches in a model that describes the growth of decomposers on two resources that contain the same essential element, one of which is organic and the other inorganic. Our model considers the elemental composition of resources and decomposers explicitly and incorporates the principle of homeostasis of elemental composition. We use this model to investigate the factors and constraints that influence the use of the two resources by decomposers, their consequences on decomposer interspecific competition, and the resulting role of decomposers in elemental cycling.

We use a graphical analysis to examine how the stoichiometry of a decomposer population controls the relative use of the two resources. We highlight how this stoichiometry, in interaction with external resource supplies, determines the impact of the decomposer population on

the cycling of the element considered. We then use the framework established in this analysis to study competitive interactions among different decomposers. By expanding the graphical analysis to two decomposer populations and using resource-ratio theory, we show how stoichiometric constraints should play a positive role in the coexistence of decomposers with different elemental compositions but drive decomposers toward colimitation by the organic and inorganic resources in the long run.

Model

Model Description

This model represents the growth of a decomposer population on two resources in a chemostat-like ecosystem (fig. 1). The first resource is made of an essential element, E, in inorganic form (E_I). The second resource contains the same essential element E (E_V), linked to organic carbon (C_V). All compartments experience some loss due to the constant renewal of a part of the medium, as in a chemostat. For simplicity, the loss rate is set to the same value l for all compartments. Again as in a chemostat, the turnover of the medium brings with it fresh resources with a concentration that is assumed to be constant (E_I^0 for the inorganic resource, C_V^0 for the organic carbon, and E_V^0 for the organic element). Tables 1 and 2 summarize the sym-

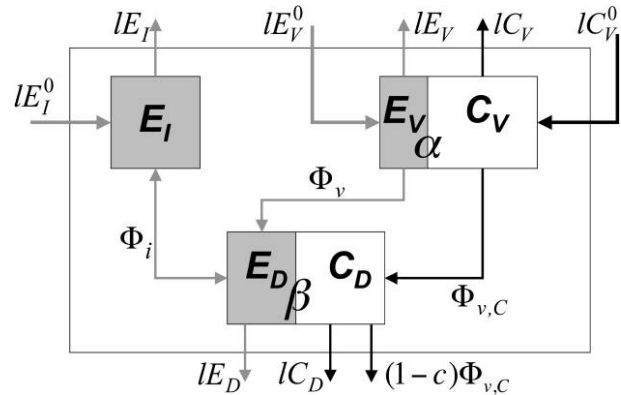

Figure 1: Diagram of our model representing the growth of a decomposer population on an inorganic resource and an organic resource containing two essential elements, carbon (C) and another element (E), in a chemostat-like system. E_I = E content of the inorganic resource; E_V = E content of the organic resource; C_V = carbon content of the organic resource; E_D = E content of decomposer biomass; C_D = carbon content of decomposer biomass; Φ_x = flux of E; $\Phi_{x,C}$ = flux of C; α = constant $C_V : E_V$ ratio; β = constant $C_D : E_D$ ratio; l = dilution rate; c = C gross growth efficiency; E_I^0 = inorganic E supply concentration; E_V^0 = organic E supply concentration; C_V^0 = organic C supply concentration.

Table 1: Summary of the symbols used in the model

Symbol	Explanation	Dimension
Φ_v	Decomposer organic E uptake flux	Quantity of E \times time ⁻¹
$\Phi_{v,C}$	Decomposer C uptake flux	Quantity of C \times time ⁻¹
Φ_i	Decomposer E_i stoichiometric adjustment flux	Quantity of E \times time ⁻¹
E_D	E stock in decomposers	Quantity of E
C_D	C stock in decomposers	Quantity of C
E_V	E stock in the organic resource	Quantity of E
C_V	C stock in the organic resource	Quantity of C
E_i	Inorganic E stock	Quantity of E
E_i^0	Inorganic E supply to decomposers	Quantity of E
E_V^0	Organic E supply to decomposers	Quantity of E
C_V^0	C supply to decomposers	Quantity of C
α	Organic resource C : E ratio	Quantity of C \times quantity of E ⁻¹
β	Decomposer C : E biomass ratio	Quantity of C \times quantity of E ⁻¹
δ	Decomposer C : E demand ratio	Quantity of C \times quantity of E ⁻¹
$\delta_{\text{imm}}^{\text{miner}}$	Value of δ that separates equilibria with mineralization from equilibria with immobilization	Quantity of C \times quantity of E ⁻¹
$\delta_{\text{C lim}}^{\text{E lim}}$	Value of δ that separates C-limited from E-limited equilibria	Quantity of C \times quantity of E ⁻¹
$\delta_{\text{C lim}}^{\text{washout}}$	Value of δ that separates C-limited equilibria with decomposers persistent from those with decomposers extinct	Quantity of C \times quantity of E ⁻¹
$\delta_{\text{washout}}^{\text{E lim}}$	Value of δ that separates E-limited equilibria with decomposers persistent from those with decomposers extinct	Quantity of C \times quantity of E ⁻¹
i	E_i uptake rate of E-limited decomposers	Quantity of E ⁻¹ \times time ⁻¹
v	Organic resource uptake rate of C-limited decomposers	Quantity of E ⁻¹ \times time ⁻¹
l	Ecosystem loss rate	Time ⁻¹
c	Decomposer C gross growth efficiency	Quantity of C \times quantity of C ⁻¹
R_i^*	E_i minimum requirement of decomposers at equilibrium	Quantity of E
R_i^{max}	Maximal E_i minimum requirement of decomposers at equilibrium	Quantity of E
R_V^*	C minimum requirement of decomposers at equilibrium	Quantity of C

Note: C = carbon; E = another potentially growth-limiting essential element.

bols used and the differential equations of the model, respectively.

The flow of carbon through the system is rather simple: it is supplied as organic C with a concentration C_V^0 , consumed by decomposers with a flux $\Phi_{v,C}$, and lost through respiration ($[1 - c] \Phi_{v,C}$) and turnover of the organic resource ($l \times C_V$) and decomposers ($l \times C_D$), where c is decomposer gross growth efficiency for C (the percentage of C ingested that is not respired) and l is the ecosystem loss rate. The element E is supplied in both an organic form with a concentration E_V^0 and an inorganic form with a concentration E_i^0 . It is lost through the turnover of decomposers ($l \times E_D$) and organic ($l \times E_V$) and inorganic ($l \times E_i$) resources. Decomposers consume organic E with a flux Φ_v . The flux between inorganic E and decomposers (Φ_i) can go in both directions, depending on the stoichiometric properties of the organic resource and of decomposers. More generally, the three fluxes Φ_p , Φ_v , and $\Phi_{v,C}$ are determined by these stoichiometric properties, as we show next.

A first stoichiometric constraint affects the organic resource, which contains C and E in a fixed ratio:

$$C_V : E_V = \alpha. \quad (1)$$

Decomposers are made of the same elements: carbon (C_D) and E (E_D). They have a fixed stoichiometric composition too:

$$C_D : E_D = \beta.$$

During the process of growth, decomposers need C and E in a ratio equal to β to build their biomass, but they also need some C to produce, through respiration, the energy necessary to this growth process. Therefore we define a third C : E ratio, δ , which represents what we call the decomposer C : E demand ratio, integrating the C and E needed to form biomass and the C needed for energy production through the formula

$$\delta = \frac{\beta}{c}, \quad (2)$$

where β is the C : E ratio of decomposer biomass and c is decomposer gross growth efficiency for C.

Table 2: Differential equations of the model describing the growth of a decomposer population using an inorganic resource containing an essential element E and an organic resource containing both E and carbon (C)

	C-limited growth	E-limited growth
Decomposer population:		
$\dot{E}_D = \Phi_V + \Phi_i - IE_D$	$\dot{E}_D = (1/\alpha)vC_V E_D + (1/\delta - 1/\alpha)vC_V E_D - IE_D$	$\dot{E}_D = [\delta/(\alpha - \delta)] iE_i E_D + iE_i E_D - IE_D$
$\dot{C}_D = c\Phi_{v,c} - IC_D$	$\dot{C}_D = \alpha C_V E_D - \delta E_D$	$\dot{C}_D = (1/\delta - 1/\alpha)^{-1} iE_i E_D - \delta E_D$
Organic resource:		
$\dot{E}_V = IE_V^0 - \Phi_V - IE_V$	$\dot{E}_V = IE_V^0 - vE_V E_D - IE_V$	$\dot{E}_V = IE_V^0 - [\delta/(\alpha - \delta)] iE_i E_D - IE_V$
$\dot{C}_V = IC_V^0 - \Phi_{v,c} - IC_V$	$\dot{C}_V = IC_V^0 - vC_V E_D - IC_V$	$\dot{C}_V = IC_V^0 - (1/\delta - 1/\alpha)^{-1} iE_i E_D - IC_V$
Inorganic resource:		
$\dot{E}_i = IE_i^0 - IE_i - \Phi_i$	$\dot{E}_i = IE_i^0 - IE_i - (1/\delta - 1/\alpha)vC_V E_D$	$\dot{E}_i = IE_i^0 - IE_i - iE_i E_D$

Note: See table 1 for definitions of symbols.

Most models of organism growth include the consumption of energy and nutrients for what is called either basal metabolism or maintenance cost. This consumption is needed to fuel the most basic processes essential to cellular life and to replace the elements inescapably lost from all cells, and so it is totally independent from the growth process. We did not feel, however, that it was an important process to include in our special case (see “Discussion”).

Decomposers obtain their carbon solely from the organic resource (C_V), with a flux $\Phi_{v,c}$ (fig. 1). Concurrently, they obtain some of the needed E from E that is linked to the carbon (E_V), with a flux Φ_v . Since the two elements are absorbed together, and given equation (1), we have

$$\Phi_{v,c} = \alpha\Phi_v. \quad (3)$$

Homeostasis of decomposer elemental composition requires that $dC_D/dt = \beta(dE_D/dt)$. From equations in table 2, we see that this stoichiometric constraint translates into the following relation between fluxes:

$$\Phi_{v,c} = \delta(\Phi_v + \Phi_i),$$

where Φ_i is a flux of E_i , adjusting for decomposer C : E composition: E_i is either taken up by the decomposers, if their organic E uptake is not sufficient to meet their E demand (immobilization), or excreted, if organic E comes in excess (mineralization).

After some algebraic manipulation using equations (2) and (3), we obtain the following stoichiometric relation between the regulating flux of E_i and the flux of ingested C:

$$\Phi_i = \left(\frac{1}{\delta} - \frac{1}{\alpha}\right)\Phi_{v,c}. \quad (4)$$

From equation (4), we understand that the two fluxes are proportional and that the factor of proportionality is simply the difference between the C : E ratio of the organic

resource and that of decomposer demand. However, we cannot deduce from this equation which of the two fluxes controls the other. But by looking at the resources that can potentially limit decomposer growth rate, we can distinguish two situations.

In the first case, E_i is insufficient to entirely complement the organic food available for uptake. In other words, decomposers are E limited and Φ_i is the growth-limiting flux. If we consider that E_i uptake in this case obeys the law of mass action, that is,

$$\Phi_i = iE_D E_i,$$

where i is the uptake rate of the inorganic resource by E-limited decomposers, then, considering equation (4), we have

$$\Phi_{v,c} = \left(\frac{1}{\delta} - \frac{1}{\alpha}\right)^{-1} iE_i E_D.$$

In the second case, E_i availability is sufficient. Decomposers are then limited by the availability of C, and Φ_v is the growth-limiting flux. In this case, applying again the mass-action law, we have

$$\Phi_{v,c} = vC_V E_D,$$

where v is the uptake rate of the organic resource by C-limited decomposers. Introducing this into equation (4) yields

$$\Phi_i = \left(\frac{1}{\delta} - \frac{1}{\alpha}\right)vC_V E_D.$$

Note that for C-limited decomposers, depending on the relative values of the C : E ratios of the organic resource and decomposer demand (α and δ), Φ_i can be negative. Due to the stoichiometric constraints on the compositions of the organic resource and the decomposers, the inorganic

resource is an unusual resource that is needed by decomposers only when their organic resource is deficient in E. The inorganic resource—when needed—cannot, in this model, be complemented by any other resource because decomposers are in absolute need of E_i in order to satisfy their E demand. Then inorganic and organic resources are essential resources (sensu Tilman 1980) for E-limited decomposers, and Liebig's law of the minimum can be applied; that is,

$$\Phi_i = \min \left[iE_i E_D, \left(\frac{1}{\delta} - \frac{1}{\alpha} \right) v C_V E_D \right]. \quad (5)$$

When $iE_i < (1/\delta - 1/\alpha)vC_V$, we are in the case of an E-limited growth where $\Phi_i = iE_i E_D$ and $\Phi_{v,c} = (1/\delta - 1/\alpha)^{-1} iE_i E_D$, whereas when $iE_i > (1/\delta - 1/\alpha)vC_V$, we are in the case of a C-limited growth where $\Phi_{v,c} = vC_V E_D$ and $\Phi_i = [(\alpha - \delta)/\alpha\delta] vC_V E_D$. One can verify easily that $\Phi_{v,c} = \min [(1/\delta - 1/\alpha)^{-1} iE_i E_D, vC_V E_D]$ could have been used instead of equation (5) and would have led to the same formulation for the two fluxes Φ_i and $\Phi_{v,c}$.

Graphical Determination of the Resource Equilibrium

Our model describes the dynamics of a population consuming two potential resources. It can be solved using the resource-ratio graphical approach developed by Tilman (1980).

Take the plane formed by all the combinations of values of the two potential resources (C_V in abscissa and E_i as an ordinate— E_v can be deduced from the former by dividing it by α). Draw on this plane the zero net growth isocline (ZNGI) for decomposer growth. The ZNGI corresponds to the set of combined values of resources that lead to a stop in net growth of decomposers. This is the case, when decomposers are C limited, for

$$\begin{aligned} C_V^* &= R_V^* = \delta \frac{l}{v}, \\ E_i^* &\geq \frac{(\alpha - \delta)l}{\alpha i}, \end{aligned} \quad (6)$$

and, when decomposers are E-limited, for

$$\begin{aligned} E_i^* &= R_i^* = \frac{(\alpha - \delta)l}{\alpha i}, \\ C_V^* &\geq \delta \frac{l}{v} \end{aligned} \quad (7)$$

(see app. A, available in the online edition of the *American*

Naturalist). Expressions (6) and (7) are simply the equations for two half lines, the union of which makes the ZNGI (fig. 2A). The two half lines are perpendicular and parallel to the axes, as is always the case for two essential resources (Tilman 1980). The point of junction of the two half ZNGIs is a particular case where both resources are limiting. It is the colimitation point (fig. 2A). The coordinates of this point (R_V^* , R_i^*) are the minimum requirements of decomposers for the two resources C_V and E_i , respectively, their R^* values according to Tilman (1980).

Notice, however, that contrary to the usual acceptance of R^* , R_i^* can be negative (fig. 2B). From equation (7), we deduce that this is the case when the decomposer C : E demand ratio, δ , is greater than the C : E ratio of the organic resource, α . It corresponds to the situation where the decomposers mineralize E_i , which in this case cannot be considered a resource anymore. The ZNGI is then only the positive part of the half line with equation $C_V^* = R_V^* = \delta(l/v)$.

We know that the resource equilibrium point is situated on the ZNGI, but more information is needed to locate its exact position. At equilibrium, we have $l(C_V^0 - C_V^*) = \Phi_{v,c}$ and $l(E_i^0 - E_i^*) = \Phi_i$ (see corresponding equations in table 2), or, written in vectorial form,

$$\begin{bmatrix} E_i^0 - E_i^* \\ C_V^0 - C_V^* \end{bmatrix} = \begin{bmatrix} \Phi_i^* \\ \Phi_{v,c}^* \end{bmatrix}.$$

The left-hand vector is the net "supply vector," while the right-hand vector is the "consumption vector" (Tilman 1980; Daufresne and Loreau 2001b). The two vectors must be exactly opposite at equilibrium (fig. 2). But we know that because of the stoichiometric constraints, $\Phi_i^*/\Phi_{v,c}^* = 1/\delta - 1/\alpha$ (eq. [4]). Thus, we also have

$$\frac{E_i^0 - E_i^*}{C_V^0 - C_V^*} = \frac{1}{\delta} - \frac{1}{\alpha}. \quad (8)$$

The resource equilibrium point (C_V^* , E_i^*) is then located at the intersection between the ZNGI and the line with slope $1/\delta - 1/\alpha$ that passes through the supply point (C_V^0 , E_i^0) (fig. 2).

The supply points located between the ZNGI and the axes (region I in fig. 2A) lead to equilibrium values of resources that would be greater than their supply values, a nonsustainable situation. They correspond to trivial equilibria, where decomposers are washed out and the resource equilibrium point coincides with the supply point (C_V^0 , E_i^0).

Supply points above the ZNGI lead to nontrivial equilibria. The line with slope $1/\delta - 1/\alpha$ that passes through the colimitation point (the colimitation line) divides this

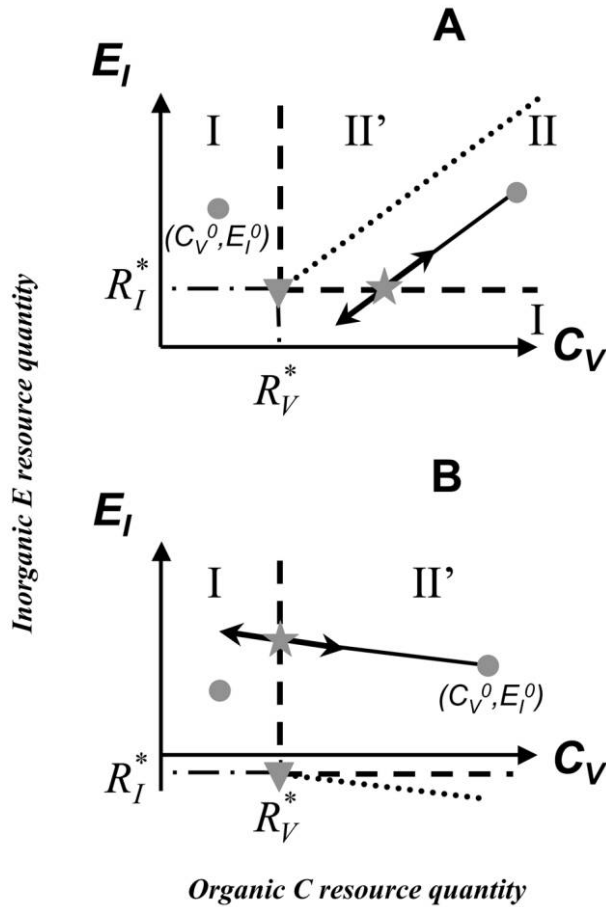

Figure 2: Graphical determination of the resource equilibrium, based on the method developed by the resource-ratio theory (Tilman 1980). In the plane formed by the two resources C_V and E_I as coordinates, the decomposer zero net growth isocline (ZNGI; dashed lines) is the set of (C_V, E_I) values that result in zero net growth of the decomposer population. The supply points (circles) are the points corresponding to the two resource supply concentrations (C_V^0, E_I^0) . For supply points in region I, the supply of resources is too low to maintain a viable decomposer population at equilibrium. Decomposers then go extinct, and the resource equilibrium point merges with the supply point. For supply points outside region I, decomposers persist at equilibrium. The resource equilibrium points (stars) are the points of each ZNGI where the consumption vector is exactly opposite to the supply vector. Since the consumption vector has a slope of $1/\delta - 1/\alpha$ and the supply vector points toward the supply point, the resource equilibrium point lies at the intersection of the ZNGI and the line with slope $1/\delta - 1/\alpha$ passing through the supply point. The colimitation line (dotted lines) is the line with the same slope that passes through the colimitation point (triangles). It divides the region of supply points that allow decomposer persistence into a region that yields E-limited equilibria (region II) and a region that yields C-limited equilibria (region II'). In A, δ , the C : E demand ratio of decomposers, is less than α , the C : E ratio of the organic resource. Decomposers have a deficit in organic E and have to immobilize E_I to maintain the constancy of their composition. In B, δ is greater than α . Decomposers have an excess of organic E and have to mineralize E_I to keep their composition constant.

part of the resource plane into two regions (regions II and II' in fig. 2A). We can see easily that supply points under this line (region II in fig. 2A) give E-limited equilibria, while supply points above it give C-limited equilibria (region II' in fig. 2A). In the case where decomposers are mineralizers (fig. 2B), only C-limited equilibria are possible.

Stoichiometry-Induced R^ Trade-Off*

In plants, for a given loss rate, the rules governing the relation between R^* values of different essential elements are not well determined; a trade-off between the competitive abilities of a species for two essential elements is often hypothesized (Tilman 1980), but this assumption has seldom been tested, and there are some counterexamples (Tilman 1981). In the case of decomposers, the simultaneous use of the organic and inorganic resources must satisfy the stoichiometric constraint of a constant composition, and this constraint results necessarily in a trade-off between the two R^* values.

For the organic resource, $R_V^* = \delta(1/v)$ is the R^* (eq. [6]; app. A). We see immediately that R_V^* is proportional to δ , the decomposer C : E demand ratio. This positive relation between these two parameters is not surprising since both of them are measures of the importance of the C demand of decomposers. The higher the percentage of C in decomposer biomass, the higher its C demand and the higher the minimum requirement for C at equilibrium (R_V^*).

For the inorganic resource, $R_I^* = (\alpha - \delta) / \alpha i$ is the R^* (eq. [7]; app. A) and is also related to δ . But here, it is negatively proportional to δ . Again, this is not surprising because δ measures the importance of E demand relative to C demand. The lower the C : E demand ratio of decomposers, the higher their relative demand for E and the higher the minimum equilibrium concentration of E_I (R_I^*) needed to complement E_V and meet the equilibrium E demand.

The trade-off between the two R^* values can be expressed analytically:

$$R_I^* = \frac{l}{i} - \frac{v}{\alpha i} R_V^*. \tag{9}$$

Thus, the colimitation point (R_V^*, R_I^*) is located on the R^* trade-off curve $E_I = l/i - (v/\alpha i) C_V$. Decomposers with different C : E demand ratios (all other parameters being kept constant) will have their ZNGIs positioned in different places on the resource plane but with all their colimitation points placed on the trade-off line (fig. 3A). The smaller the C : E demand ratio, the lower the minimum C requirement of decomposers at equilibrium (R_V^*) and the higher their minimum E_I requirement (R_I^*). Graphi-

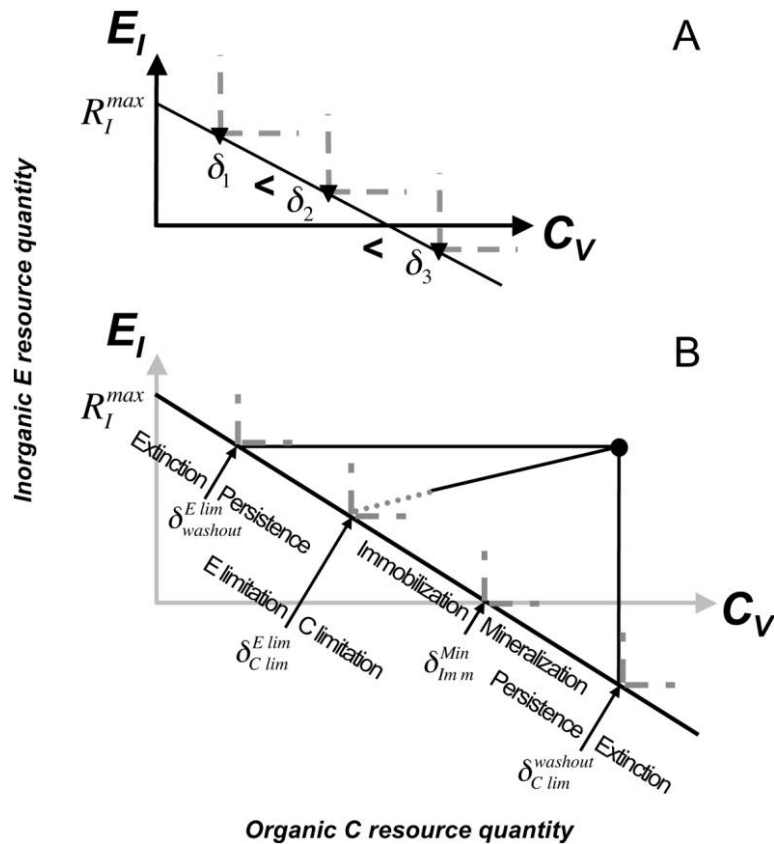

Figure 3: A, Changes in the location of the decomposer zero net growth isocline (ZNGI; dashed line) with δ , the C : E demand ratio of decomposer biomass. As δ varies, all other parameters being constant, the colimitation point (triangles) that lies at the corner of the ZNGI moves along the R^* trade-off curve (solid line). The smaller δ , the closer the ZNGI to the Y-axis and the colimitation point to the point $(0, R_1^{\max})$. B, Graphical determination of the various δ threshold values that delimit equilibria with different properties. The parameter $\delta_{\text{imm}}^{\text{min}}$ separates δ values that result in immobilization by decomposers from those that result in mineralization. The decomposer colimitation point lies at the intersection between the R^* trade-off curve and the X-axis. The ZNGI (dashed line) then has its E-limited half-confounded with the X-axis. The parameter $\delta_{\text{C lim}}^{\text{E lim}}$ separates δ values that result in E-limited equilibria from those that result in C-limited equilibria. The colimitation line (dotted line) with slope $1/\delta - 1/\alpha$ then passes through the supply point (filled circle), and the resource equilibrium point is confounded with the colimitation point. The parameter $\delta_{\text{C lim}}^{\text{washout}}$ separates δ values that result in C-limited equilibria with a viable decomposer population from those that result in C-limited equilibria with an extinct decomposer population. The supply point then lies on the C-limited half of the decomposer ZNGI. The parameter $\delta_{\text{E lim}}^{\text{washout}}$ separates δ values that result in E-limited equilibria with a viable decomposer population from those that result in E-limited equilibria with an extinct decomposer population. The supply point then lies on the E-limited half of the decomposer ZNGI.

cally, this translates into the fact that the smaller the δ ratio, the closer the colimitation point to the Y-axis (fig. 3A). In the limiting case where the C : E demand ratio tends to 0, R_V^* also tends to 0 and R_1^* tends to a maximum value R_1^{\max} equal to l/i . In a first interpretation, R_1^{\max} can be understood as the R_1^* of decomposers with C demand considerably less than their E demand. This may not look like a biologically realistic situation, but an alternative approach may help us to better grasp the biological meaning of the parameter R_1^{\max} . From the analytical expression of $R_1^* = (\alpha - \delta) l / \alpha i$, we can see that $R_1^{\max} = l/i$ can be reached when α , the C : E ratio of the organic resource, tends to infinitely high values. Here the biological inter-

pretation of R_1^{\max} is straightforward: it is simply the concentration to which E_1 is driven by E-limited decomposers when these have an organic resource with only traces of E.

Definition and Graphical Determination of δ Threshold Values

The identity of the limiting element at equilibrium, as well as the persistence of decomposers at equilibrium, depends on the relative positions of the ZNGI and the supply point (fig. 2). Since a change in the decomposer C : E demand ratio δ leads to a change in the position of the ZNGI, some

values of δ will result in equilibria where C limits decomposer growth, while others will produce E-limited equilibria. Some will result in the extinction of decomposers, while others will allow for their persistence at equilibrium. Some will lead to mineralization, others to immobilization of E_1 . These various contrasts lead to the definition of different threshold values of δ , which can be calculated analytically.

The first of these threshold values, $\delta_{\text{imm}}^{\text{miner}}$, separates the decomposer C : E demand ratios that lead to equilibria for which decomposers mineralize E from those that result in equilibria where decomposers immobilize E. Decomposers with δ exactly equal to this threshold value do not immobilize or mineralize E, and so they do not have any requirement for E_1 at equilibrium ($R_1^* = 0$). They have relative C and E demands that perfectly match the C : E ratio of their organic resource, which explains why $\delta_{\text{imm}}^{\text{miner}}$ is equal to the organic resource C : E ratio. The position of their ZNGI can be determined easily because their colimitation point (R_v^* , R_1^*) is at the intersection of the R^* trade-off curve with the X-axis (fig. 3B). Decomposers with other C : E demand ratios immobilize for ratios less than $\delta_{\text{imm}}^{\text{miner}}$ and mineralize for ratios greater than $\delta_{\text{imm}}^{\text{miner}}$.

The second threshold value, $\delta_{\text{Clim}}^{\text{Elim}}$, is the decomposer C : E demand ratio that separates E-limited equilibria from C-limited equilibria. It is the unique value of δ where decomposers are colimited by the two elements E and C. In this case, the E_1 concentration at equilibrium needed by decomposers for sustainable growth (E_1^*) is just enough to provide the complement of E needed by the decomposers to grow on the C_v concentration available at equilibrium. Graphically, it is the value of δ for which the supply point lies on the colimitation line (fig. 3B). When δ is greater than $\delta_{\text{Clim}}^{\text{Elim}}$, a higher decomposer C demand leads to a C-limited equilibrium, while when δ is less than $\delta_{\text{Clim}}^{\text{Elim}}$, a higher E requirement leads to an E-limited equilibrium.

Two threshold values of δ separate equilibria where decomposers are persistent from equilibria where they are driven to extinction, one for each type of elemental limitation (E and C limitation). Among decomposer C : E demand ratios leading to C-limited equilibria, $\delta_{\text{Clim}}^{\text{washout}}$ is the value for which the supply of C, C_v^0 , matches precisely the minimum C_v decomposer requirement at equilibrium, R_v^* . Since the entire C supply at equilibrium is required in the form of organic resource C_v , there is no C left for building biomass, and decomposers go extinct. But the slightest increase in the supply of C or decrease in the decomposer C : E demand ratio would lead to the appearance of a small viable decomposer population at equilibrium. Thus, $\delta_{\text{Clim}}^{\text{washout}}$ marks the transition between C : E demand ratios leading to sustainable decomposer populations at equilibrium (when δ is less than $\delta_{\text{Clim}}^{\text{washout}}$) and

C : E demand ratios conducive to the extinction of decomposers (when δ is greater than $\delta_{\text{Clim}}^{\text{washout}}$). Graphically, it is the value of δ for which the supply point lies on the half ZNGI holding the C-limited equilibria (fig. 3B).

The equivalent threshold value for E-limited equilibria, $\delta_{\text{washout}}^{\text{Elim}}$, is the decomposer C : E demand ratio for which the supply of E_1 is hardly sufficient to sustain an E-limited decomposer population at equilibrium. When the decomposer C : E demand ratio is less than $\delta_{\text{washout}}^{\text{Elim}}$, the minimum equilibrium E requirement of decomposers cannot be met, and decomposers go extinct. When the decomposer C : E demand ratio is greater than $\delta_{\text{washout}}^{\text{Elim}}$, their equilibrium E requirement is satisfied, and equilibria with a viable decomposer population are possible. Graphically, $\delta_{\text{washout}}^{\text{Elim}}$ is the value of δ for which the supply point lies on the half ZNGI holding the E-limited equilibria (fig. 3B).

Determination of the Properties of the Equilibrium by Resource Supplies, R^ Trade-Off, and Decomposer Elemental Composition*

The four threshold values defined in the preceding section, $\delta_{\text{imm}}^{\text{miner}}$, $\delta_{\text{Clim}}^{\text{Elim}}$, $\delta_{\text{Clim}}^{\text{washout}}$, and $\delta_{\text{washout}}^{\text{Elim}}$, can be calculated or found graphically for any supply point (C_v^0 , E_1^0). But for a given supply point, some of these values may result in unfeasible equilibria. The most evident case is when the supply point is situated below the R^* trade-off curve, a case that is represented in figure 4A. In that situation, for all values of δ , at least one of the resource supplies C_v^0 and E_1^0 is below its corresponding equilibrium requirement. The medium is simply not rich enough for any kind of decomposers to persist, and these are always washed out, given enough time (fig. 4A'). Here, $\delta_{\text{Clim}}^{\text{washout}}$ and $\delta_{\text{washout}}^{\text{Elim}}$, which mark the transitions between persistent and non-persistent equilibria, are not feasible, and $\delta_{\text{imm}}^{\text{miner}}$ and $\delta_{\text{Clim}}^{\text{Elim}}$ are not meaningful because decomposers are extinct at equilibrium and no mineralization, immobilization, or growth limitation occurs.

For supply points located above the R^* trade-off curve (fig. 4B–4E), there is always a range of decomposer C : E demand ratios where the supply point is above the ZNGI, producing persistent decomposer populations at equilibrium. For supply points located as in fig. 4B, we can see graphically that $0 < \delta_{\text{washout}}^{\text{Elim}} < \delta_{\text{Clim}}^{\text{Elim}} < \delta_{\text{imm}}^{\text{miner}} < \delta_{\text{Clim}}^{\text{washout}}$. For E-limited decomposers to be persistent, their C : E demand ratio must, first, be among the values that result in E-limited equilibria, which is true for $\delta < \delta_{\text{Clim}}^{\text{Elim}}$ (limitation condition), and, second, be among the values that lead to persistent E-limited decomposers, that is, with $\delta > \delta_{\text{washout}}^{\text{Elim}}$ (persistence condition). E-limited persistent decomposers are thus possible only for $\delta_{\text{washout}}^{\text{Elim}} < \delta < \delta_{\text{Clim}}^{\text{Elim}}$. In the same way, C-limited persistent equilibria are reached for $\delta_{\text{Clim}}^{\text{Elim}} < \delta < \delta_{\text{Clim}}^{\text{washout}}$. The range of C : E demand ratios

leading to persistent equilibria is then $\delta_{\text{Clim}}^{\text{Elim}} < \delta < \delta_{\text{Clim}}^{\text{washout}}$ (fig. 4B'). Mineralization takes place only with C-limited decomposers because E-limited decomposers consume E_i instead of mineralizing it. Also, the decomposer population must be persistent if there is to be a nonzero mineralization flow at equilibrium, that is, δ is to be lower than $\delta_{\text{Clim}}^{\text{washout}}$ (persistence condition for mineralization). Since decomposers at equilibrium mineralize only for C : E demand ratios greater than $\delta_{\text{imm}}^{\text{miner}}$ (stoichiometric condition for mineralization), mineralization occurs for $\delta_{\text{imm}}^{\text{miner}} < \delta < \delta_{\text{Clim}}^{\text{washout}}$ (fig. 4B').

In the case shown in figure 4C, the supply concentration of E_i , E_i^0 , is greater than R_i^{max} , the highest possible R_i^* value. Thus, E_i^0 is always greater than R_i^* , the decomposer E_i minimum requirement, and all E-limited equilibria are persistent. Here, we have $\delta_{\text{washout}}^{\text{Elim}} < 0 < \delta_{\text{Clim}}^{\text{Elim}} < \delta_{\text{imm}}^{\text{miner}} < \delta_{\text{Clim}}^{\text{washout}}$, and decomposers are persistent for $0 < \delta < \delta_{\text{Clim}}^{\text{washout}}$ (fig. 4C').

The case in figure 4D is close to that of figure 4B, with the lowest values of decomposer C : E demand ratios leading to the extinction of E-limited decomposers ($0 < \delta < \delta_{\text{washout}}^{\text{Elim}}$). But a difference lies in the fact that $\delta_{\text{Clim}}^{\text{washout}}$ is less than $\delta_{\text{imm}}^{\text{miner}}$. Mineralization is possible only for decomposer C : E demand ratios greater than $\delta_{\text{imm}}^{\text{miner}}$, but all the values of δ that would lead to mineralization are also greater than $\delta_{\text{Clim}}^{\text{washout}}$ and correspond to nonpersistent equilibria (fig. 4D). This explains why, in this case, there cannot be mineralization for any value of the decomposer C : E demand ratio.

The last situation, in figure 4E and 4E', shares with the case in figure 4C the fact that all E-limited equilibria are persistent. It shares with the case in figure 4D the absence of δ values resulting in mineralization.

From the different cases illustrated in figure 4, we can draw some conclusions on the links between resource supplies and the feasibility of the different equilibria: (1) When the supply of inorganic resource (E_i^0) is greater than R_i^{max} (fig. 4C, 4E), the minimum requirement of decomposers for E_i is always smaller than E_i^0 . Hence, the supply of E_i is always sufficient to sustain E-limited decomposer growth at equilibrium, even for decomposers with high demands for E (small values of δ). (2) Mineralization is possible only when the supply of organic C (C_v^0) is sufficiently high (fig. 4B, 4C). When C_v^0 is too low, as in figure 4D and 4E, decomposer C : E demand ratios that would result in mineralization do not allow the persistence of decomposers at equilibrium. Mineralization is thus possible only for ecosystems that are rich in organic resources and for decomposers with C : E demand ratios greater than the C : E ratio of their organic resource.

Competition between Decomposers with Different Elemental Compositions

The resource-ratio theory has been extended straightforwardly from the study of one plant population to the case

of two or more different plant species competing for two resources (Tilman 1980). Our model can also be extended to study the competition between two decomposer species differing in their C : E demand ratios. We just have to introduce a new decomposer species and its associated material fluxes with two resources. The introduced species differs from the first decomposer species only in its δ ratio; we assume that all the other parameters are equal.

There are two conditions to make coexistence between two species sharing two resources possible (Tilman 1980). First, because the equilibrium point lies necessarily at the intersection of the two ZNGIs, the two ZNGIs must intersect in at least one point. Because of the stoichiometric constraints, the two decomposers have their colimitation points located on the R^* trade-off curve; hence, the two ZNGIs necessarily intersect (fig. 5).

At the equilibrium point, the two species are limited by different resources: the population species with the lower C : E demand ratio δ (species 1 in fig. 5A) is E limited, while the other (species 2 in fig. 5A) is C limited. The second condition for possible coexistence is that each species consume relatively more of the resource that limits its own growth rate (Tilman 1980). In our particular case, it means that species 1 should consume more E_i than does species 2 at equilibrium, and species 2 should consume more C_v than does species 1 at equilibrium. At equilibrium, each species has its own consumption vector:

$$\vec{c}_1 = \begin{bmatrix} \Phi_{i,1}^* \\ \Phi_{v,C,1}^* \end{bmatrix}$$

for species 1, and

$$\vec{c}_2 = \begin{bmatrix} \Phi_{i,2}^* \\ \Phi_{v,C,2}^* \end{bmatrix}$$

for species 2. Because of the stoichiometric constraints, \vec{c}_1 and \vec{c}_2 have slopes

$$p_1 = \frac{1}{\delta_1} - \frac{1}{\alpha},$$

$$p_2 = \frac{1}{\delta_2} - \frac{1}{\alpha}, \quad (10)$$

respectively. If we remember that $\delta_1 < \delta_2$, we deduce immediately from equation (10) that $p_1 > p_2$ (fig. 5). In terms of resource consumption, this translates simply into the fact that species 1 does consume more E_i than does species 2, and species 2 does consume more C_v than does species 1 at equilibrium, thus fulfilling the second condition. Hence, the stoichiometric constraints on decomposer

Inorganic E resource quantity

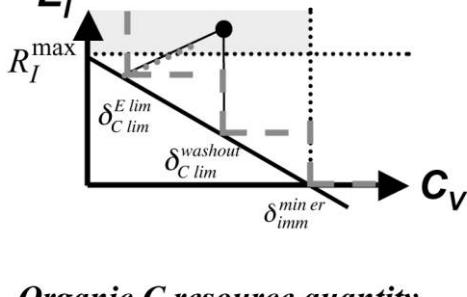
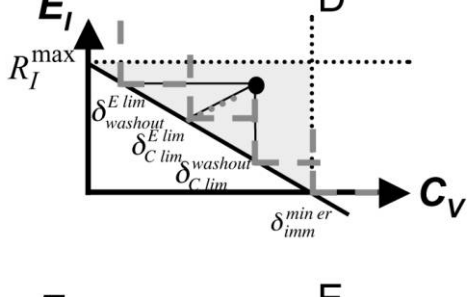
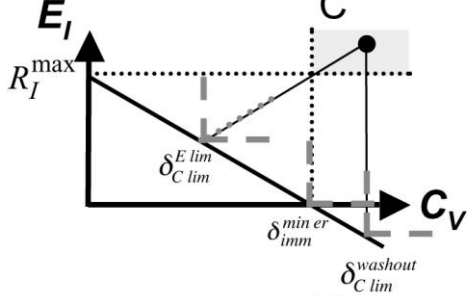
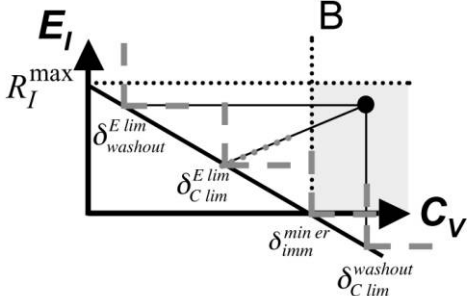
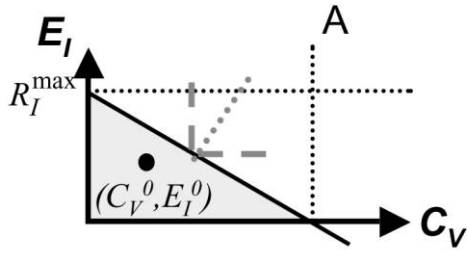

Organic C resource quantity

Decomposer E stock

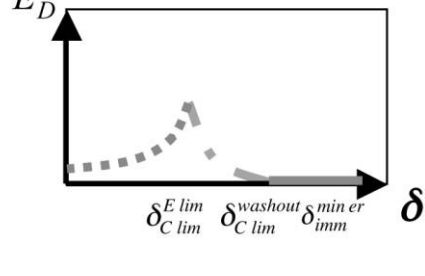
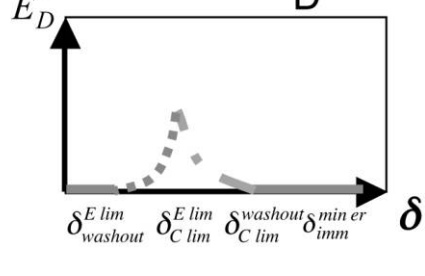
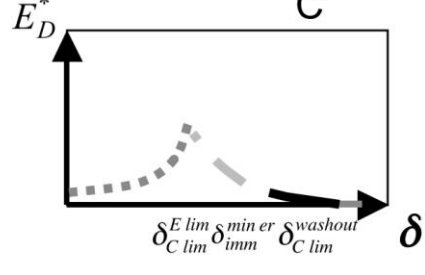
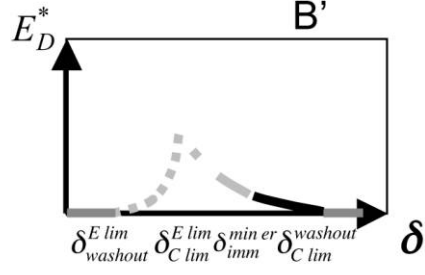
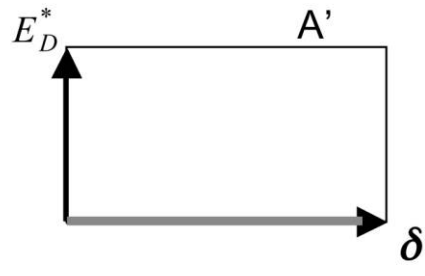

Decomposer C:E demand ratio

composition result automatically in the satisfaction of the first two conditions necessary for the coexistence between decomposer species that differ in their δ ratios.

The last sufficient condition for coexistence depends on the position of the supply point, which has to be located in the region of the plane delimited by the extension of the two consumption vectors \vec{c}_1 and \vec{c}_2 (fig. 5A). As is shown graphically in figure 5A and can be justified straightforwardly with geometrical arguments, the last two conditions are fulfilled when the two single-species resource equilibrium points are located above the two-species resource equilibrium point. When at least one of the single-species equilibrium points is situated below the two-species equilibrium, as is the case for species 2 in figure 5B, the supply point cannot belong to the region delimited by the extension of the two consumption vectors, and the last condition for coexistence is not fulfilled. If one of the two single-species equilibrium points lies below the two-species equilibrium point ($R_{V,2}^*$, $R_{I,1}^*$), either $E_{I,2}^*$ is less than $R_{I,1}^*$ or $C_{V,1}^*$ is less than $R_{V,2}^*$ (as is the case in fig. 5B). In the first case, species 2 is still able to grow for values of E_I slightly lower than $R_{I,1}^*$, the two-species equilibrium value, but species 1 cannot do so and hence is excluded competitively. In the second case, illustrated in figure 5B, it is species 1 that wins the competition because it is able to grow for values of C_V slightly lower than $R_{V,2}^*$ while species 2 is not. When the two single-species equilibrium points lie below the two-species equilibrium point, the two consumption vectors are not even in the appropriate arrangement to fulfill the second condition for coexistence (not shown in fig. 5).

A corollary of the last coexistence condition is that two decomposer species limited by the same element when alone cannot coexist (fig. 5B): if the two species are C limited, $C_{V,1}^*$ is equal to $R_{V,1}^*$, which is less than $R_{V,2}^*$ because δ_1 is less than δ_2 . So it is species 1 that wins the competition (as is the case in fig. 5B). If the two species are E limited, $E_{I,2}^*$ is equal to $R_{I,2}^*$, which is less than $R_{I,1}^*$ because δ_2 is greater than δ_1 . In that case, species 1 is competitively excluded. A consequence is that, given enough time for evolution of the decomposer C : E demand ratio δ , coexisting decomposers should converge

toward colimitation by C and E because E-limited decomposers will be outcompeted by E-limited decomposers with greater C : E demand ratios and C-limited decomposers will be outcompeted by C-limited decomposers with lower C : E demand ratios.

In summary, there are three conditions for the coexistence of two species of decomposers competing for an inorganic resource and an organic resource. First, the two ZNGIs must intersect. Second, each species must consume relatively more of the resource that limits its own growth rate. Third, the supply point must be located in the region of the plane delimited by the extension of the two consumption vectors (Tilman 1980). Stoichiometric constraints on the relative consumption of the two resources ensure that the first two conditions are fulfilled. Fulfillment of the third condition is not made easier by stoichiometric constraints. However, we show that the second and third conditions can be combined into a single condition: the two single-species resource equilibrium points must lie above the two-species resource equilibrium point. Because of stoichiometric constraints, this condition should result, by means of species replacement or adaptation, in the convergence of decomposer communities toward colimitation by C and E.

Discussion

The model developed here applies the methodology elaborated mainly for plants in the resource-ratio theory to the growth of microbial decomposers on two elements, carbon (C) and another element (E), which could be phosphorus, nitrogen, iron, or any other potentially growth-limiting essential element. These two elements are contained in two resources available to decomposers. One resource contains only E in inorganic form. The second resource is organic and is made of both C and E. The improvement brought by this model, compared with the usual models employed in resource-ratio theory, lies in the introduction of constraints on the elemental compositions of the organic resource and of decomposer demand by imposing a constant C : E ratio. The addition of these stoichiometric constraints leads to a set of new insights

Figure 4: Effects of the location of the resource supply point (C_V^0, E_I^0 ; filled circles) on the feasibility of the various possible equilibria of a decomposer population growing on an inorganic (E_I) and an organic (C_V) resource according to model 1 (A–E) and on the variation in equilibrium decomposer biomass (E_I^*) as a function of the decomposer C : E demand ratio δ (A'–E'). The feasibility of the equilibria can be deduced from the order of the δ threshold values (defined in fig. 3). In A, the supply point lies below the R^* trade-off curve (solid line), and decomposers go extinct. Equilibrium decomposer biomass is 0 for all δ values as shown in A'. In B, $E_I^0 < R_{I,1}^{\max}$, so decomposers with low values of δ go extinct. The value of C_V^0 is sufficiently high for mineralization (C', solid line) to occur for decomposers with a δ ratio between $\delta_{\text{lim}}^{\text{miner}}$ and $\delta_{\text{lim}}^{\text{washout}}$, as shown in B'. In C, $E_I^0 > R_{I,1}^{\max}$, and all E-limited decomposers are persistent at equilibrium (C', dotted line). The value of C_V^0 is still sufficient for mineralization. In D, $E_I^0 < R_{I,1}^{\max}$, but now C_V^0 is too low and C-limited persistent decomposers (D', dot-dashed line) immobilize E at equilibrium. In E, $E_I^0 > R_{I,1}^{\max}$, and C_V^0 is too low for mineralization.

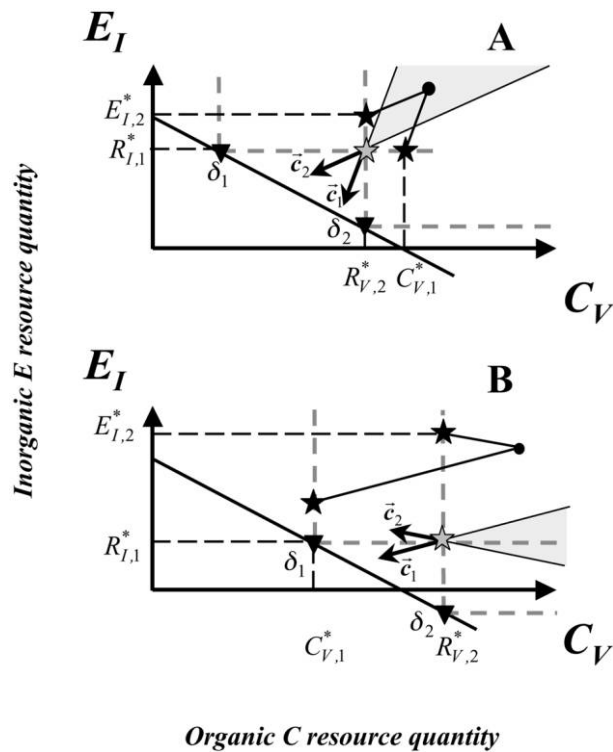

Figure 5: Graphical determination of the resource equilibrium point and its stability in the case of two competing decomposer populations that differ only in their δ values (δ_1 and δ_2). The resource equilibrium point (gray stars) is located at the intersection of the two zero net growth isoclines (ZNGIs). Because the two colimitation points lie on the R^* trade-off curve, the two ZNGIs necessarily intersect and the equilibrium is feasible. At this equilibrium, decomposers with ratio δ_1 are E limited, while decomposers with ratio δ_2 are C limited. For the equilibrium to be stable, each decomposer must consume more of the resource that limits its own growth. In this model this condition is always fulfilled, as can be seen from the relative positions of the two consumption vectors \vec{c}_1 and \vec{c}_2 (see Tilman 1980). This is the case because the ratio of $E_I : C_V$ consumed at equilibrium, $1/\delta - 1/\alpha$, is greater for decomposers with ratio δ_1 than for those with ratio δ_2 . The last condition for coexistence requires that the two single-species resource equilibrium points (black stars) be above the two-species resource equilibrium point. Only when this condition is fulfilled does the supply point (filled circles) belong to the region of the plane delimited by the extension of the two consumption vectors. This last condition is met in A but not in B.

and predictions, in particular, (1) a trade-off between the R^* values of the two resources, (2) favorable conditions for the coexistence of decomposers that have demands with different elemental ratios, and (3) convergence of the decomposer community, through species replacement or evolution, toward colimitation by the organic and inorganic resources. The homeostasis of decomposer stoichiometry and the difference between the elemental composition of the organic resource and of the demand of

decomposers are the key factors responsible for these predictions.

To reach our predictions on the coexistence and evolution of competing decomposers, we examined the variation of a single parameter, namely, the decomposer C : E demand ratio, while keeping all other parameters constant. We also performed an equilibrium analysis and assumed that environmental parameters, such as resource supplies and loss rates, were constant. Although these restrictions may limit the generality of our predictions, we feel that lifting them would be out of the scope of this article and would not affect our main point, that stoichiometric constraints are the source of a trade-off between the R^* values of the two resources and a factor favoring the coexistence of decomposers that differ in their relative demands for the two elements. We anticipate that letting decomposers vary in parameters other than their C : E demand ratio will not have a systematic impact on coexistence unless these parameters are correlated to the demand ratio. We also expect that environmental variability will generally prevent the competitive interaction from reaching its conclusion and, hence, facilitate coexistence and delay the long-term convergence of decomposers to colimitation by the organic and inorganic resources. More detailed studies on these issues, however, would be useful.

Two important assumptions of our model require some discussion: the constancy of decomposer elemental composition and that of carbon gross growth efficiency, which together result in the constancy of the decomposer C : E demand ratio. The assumption that single-species decomposer elemental composition is constant is still open to debate. There are a number of studies on variation in the chemical composition of different organisms (e.g., Sterner and Elser 2002; Evans-White et al. 2005), but few of them deal with variation in the chemical composition of microbial decomposers such as bacteria and fungi. There is a fundamental difference between autotrophs, which can experience large variations in their elemental composition, and metazoans, which have much smaller variations (Sterner and Elser 2002). Bacteria seem to lean more toward the case of metazoans, with much less variation than autotrophs (Makino et al. 2003). But some variation does exist among individual strains of bacteria (Vrede et al. 2002). Although a comprehensive review of the factors causing variations in microbial elemental composition is still lacking, it seems from current knowledge that growth rate is the most important factor controlling the variation of the element that limits growth (Vrede et al. 2002; Makino et al. 2003), while both growth rate and element supply control the variation of nonlimiting elements (Vrede et al. 2002; Zinn et al. 2004). Because our analysis was performed at equilibrium, as long as the loss rate—which is equal to the growth rate at equilibrium—is con-

stant, there should not be any change in the elemental composition of decomposers due to variation in their growth rate. Supply of the nonlimiting element is also important because it influences the amount of this element stored by decomposers at equilibrium (Herbert 1976; Zinn et al. 2004). The storage capacity of decomposers generally decreases with their growth rate (Vrede et al. 2004; Zinn et al. 2004), and some elements, such as nitrogen, do not seem to be stored at all. Hence, our hypothesis of a constant composition is appropriate for high growth rates and for some elements, such as nitrogen.

Carbon gross growth efficiencies measured in nature are highly variable (del Giorgio and Cole 1998). As for decomposer elemental composition, it seems that growth rate and resource supply are the main drivers of these variations (Cajal-Medrano and Maske 2005; Lennon and Pfaff 2005; Jansson et al. 2006). Most of these studies, however, concern bacterial assemblages, and shifts in community composition might be a better explanation of these variations than physiological plasticity of single species (Eiler et al. 2003). Hence, it is still difficult, based on current knowledge, to form conclusions on the constancy or variation in the carbon gross growth efficiency of decomposers. This parameter is also important because it determines the intensity of the mismatch between the C:E ratios of decomposer demand and elemental composition. A poor estimation of carbon gross growth efficiency may lead to an erroneous assumption that decomposers mineralize or immobilize the inorganic resource and thus may conceal their true function in the ecosystem. For all these reasons, we see the study of this physiological parameter and of the factors that govern its variations as a key target for future microbial ecological studies.

Contrary to many models of microbial growth, our model also assumes that there is no consumption of C and E for basal metabolism. It is commonly assumed that losses of C and E for maintenance are small, constant fractions of decomposer biomass (Marr et al. 1962). The introduction of a constant mass-specific basal metabolic rate in accordance with this assumption should not bring qualitative changes to our predictions. This rate would simply add to the loss rate l . Because of these increased losses of C and E in decomposers, the model would deviate from the conditions of a chemostat, which would make the calculations of equilibrium values, threshold values, stability conditions, and feasibility conditions a little more complicated but would not yield qualitatively different results. One qualitative difference would appear in the special case where the supply and loss rates of one resource are 0. Our model predicts the persistence of decomposers after they have exhausted the amount of the nonrenewed resource present in the ecosystem, while the addition of a basal metabolic rate would predict that decomposers

burn their own biomass until extinction. However, many microbial decomposers are known to have resistance forms, such as spores or dormant stages, that have negligible maintenance costs, and thus our model might be closer to reality even in this very special case of starvation in a closed ecosystem. Models such as those of Thingstad and Pengerud (1985) and Thingstad (1987) explicitly introduced variation in C:P composition and/or maintenance costs, but these improvements did not bring conclusions that differ drastically from our conclusions on the common issues addressed by the various models, and they did not address the main topic of interest of this article, namely, the use by decomposers of a resource that contains both carbon and another element and its consequences on their species interactions and their role in elemental cycling.

In resource-ratio theory, the coexistence of two decomposer populations requires that each of them be limited by a different resource at equilibrium and that each consume proportionately more of the resource that limits its own growth (Tilman 1980). Because the theory links the relative consumption of an element to its relative demand for growth, we predict that the stoichiometric constraints on the elemental compositions of the organic resource and decomposers should help fulfill these two conditions and make coexistence on the two resources possible, given adequate resource supplies. Resource competition between different decomposer strains or species has rarely been addressed experimentally (e.g., Vadstein 1998; Basson 2000; Celar 2003; Diedhiou et al. 2004) and certainly never by using organic resources that combine two limiting elements or by looking for differences in elemental composition between competitors. Therefore, it is premature to draw conclusions on the validity of this result. Our model, however, seems a promising path to understanding decomposer community structures. It is known, for example, that bacteria and fungi have different C:P and C:N ratios and that substrate C:N ratio can have an influence on fungal/bacterial biomass ratios (Eiland et al. 2001). If we also consider the vast number of limiting resources created by the combination of the various essential elements (C, N, P, Fe, etc.) in organic resources with different possible elemental ratios (parameter α in our models), we see that this stoichiometry-enhanced mechanism of coexistence has a great potential for explaining the high diversity that is usually encountered in natural decomposer communities. A last necessary condition for coexistence concerns the location of the supply point, which must belong to the region delimited by the extension of the consumption vectors of the two competing species (Tilman 1980). We have shown graphically that the second and third conditions are fulfilled if and only if the two single-species equilibrium points are lo-

cated above the two-species equilibrium point, which lies at the intersection of the ZNGIs of the two decomposer species. Although we derived this condition in the specific context of our model, it is general for all kinds of consumers. The condition that the two ZNGIs must intersect and the condition that the two single-species equilibrium points must lie above the two-species equilibrium point are necessary and sufficient to ensure the stable coexistence of any two species competing for two resources. The biological interpretation of these two conditions is straightforward: coexistence is stable if the two species exhibit a trade-off in their minimum resource requirements at equilibrium and if each species on its own requires more of the resource limiting the other species at equilibrium than does its competitor. Our reformulation of Tilman's (1980) three conditions for coexistence into these two new conditions also has a practical advantage: it is generally more difficult to estimate the supply rate of resources in the field than to measure their concentrations and determine which one is limiting. Therefore, we hope that our work will facilitate the use of resource-ratio theory in field studies, outside of the realm of experimental and theoretical studies (Miller et al. 2005).

We showed that decomposers limited by the same resource when alone cannot coexist and that, by means of species replacement or evolution of their C : E demand ratio, decomposers should converge along the R^* trade-off curve toward colimitation by the inorganic and organic resources. Hence, even though stoichiometry is a potent mechanism with which to explain diversity of consumers on an ecological time scale (Hall 2004; Loladze et al. 2004), it might prove insufficient on the time scale of evolution because, in absence of other factors, colimitation, which is the best strategy of resource use, will always dominate ultimately. Therefore, other mechanisms, such as environmental variability or trade-offs between the decomposer elemental demand ratio and other growth-related parameters, might be needed to account for microbial decomposer diversity.

Other studies have already extended resource-ratio theory to decomposer growth on two resources (see Smith 1993). In contrast to the work of these earlier studies, however, we were able to derive an explicit trade-off between the R^* of the two resources that has far-reaching consequences for the coexistence of competing decomposers. In fact, in many previous models, C and E were assumed to be totally separate resources for decomposers (Thingstad and Pengerud 1985; Thingstad 1987). As a result, the inorganic element E was always immobilized and never mineralized, the amount of inorganic E consumed at equilibrium when it was limiting was independent of the C : E ratios of decomposers and of the organic resource, and no trade-off between the R^* of the two re-

sources could be deduced directly from their equilibrium values. A few models examined the use by decomposers of an organic resource that contains both C and E and its relation to the use of inorganic E, but they were simulation models (Parnas 1975; Vallino et al. 1996; Touratier et al. 1999).

All our results about decomposer competition are valid for other kinds of consumers as long as there is a trade-off between the R^* of the two resources resulting from constraints on the demand ratio for the two resources. For situations in which C and E are physically separated, as is the case with plants consuming essential resources, such a trade-off was hypothesized based on optimal foraging theory (Tilman 1980, 1986). In our study, in which C and E are partially linked, this trade-off arises from stoichiometric constraints and facilitates the coexistence of two consumer species limited by different elements. A study of grazer competition by Loladze et al. (2004), in which C and E were totally coupled, concluded that stoichiometric constraints could lead to the coexistence of consumers limited by the same element. Thus, in addition to the elemental ratios that are traditionally considered in stoichiometric studies, the way in which these elements are linked in resources seems to play an important role in determining the growth and competitive interactions of consumers. It would be interesting to study this factor in a more systematic way.

Decomposers compete for inorganic resources not only with each other but also with primary producers. Many studies have addressed the issue of coexistence between primary producers and decomposers to resolve the apparent paradox of primary producers providing a much-needed organic resource to decomposers, their main competitors for inorganic resources (Currie and Kalff 1984; Bratbak and Thingstad 1985; Daufresne and Loreau 2001a; Mindl et al. 2005). Our current work is a useful basis for predicting when decomposer interactions with primary producers change from competition to mutualism and from coexistence to competitive exclusion because it identifies the conditions under which decomposers switch from immobilizing the inorganic resource to mineralizing it and from carbon limitation to inorganic resource limitation (M. Cherif and M. Loreau, unpublished data).

Based on resource-ratio and ecological stoichiometry theories, our model yields interesting new predictions and perspectives on important aspects of community structure and ecosystem functioning related to microbial decomposers. Most of these new predictions result from the stoichiometric constraints that act on the elemental composition of decomposer demand and their organic resources. First, stoichiometric constraints generate a trade-off between the abilities of decomposers to utilize an inorganic element and an organic resource containing this same el-

ement. As a consequence of this trade-off, coexistence is facilitated between decomposer types that have different elemental demand ratios, even though, in the long run, they should evolve toward the demand ratio that results in colimitation of growth by the organic resource and the inorganic element. Because of the diversity of elemental compositions of inorganic resources, organic resources, and decomposers, we expect this stoichiometry-related trade-off to be an important mechanism in explaining the diversity of decomposer communities. Second, we predict that decomposers will be mineralizers only in ecosystems that are rich enough to provide the quantity of organic resources needed by mineralizing decomposers, which are more demanding of carbon. Since other organisms provide these organic resources, we intend to use our model as a basis for studying the interactions between decomposers and the other major trophic levels in ecosystems.

Acknowledgments

We are most grateful to C. de Mazancourt for her precious advice that led to a substantial improvement of our manuscript. We are also thankful to our reviewers and editors. M.C. was supported by a grant from the French Ministry of Research and Education. M.L. acknowledges a Discovery grant from the Natural Sciences and Engineering Research Council of Canada. This work was supported by an ACI ECCO-PNBC grant from the Centre National de la Recherche Scientifique, France.

Literature Cited

- Andr n, O., and J. Balandreau. 1999. Biodiversity and soil functioning: from black box to can of worms? *Applied Soil Ecology* 13: 105–108.
- Basson, N. J. 2000. Competition for glucose between *Candida albicans* and oral bacteria grown in mixed culture in a chemostat. *Journal of Medical Microbiology* 49:969–975.
- Bratbak, G., and T. F. Thingstad. 1985. Phytoplankton-bacteria interactions: an apparent paradox? analysis of a model system with both competition and commensalism. *Marine Ecology Progress Series* 25:23–30.
- Cajal-Medrano, R., and H. Maske. 2005. Growth efficiency and respiration at different growth rates in glucose-limited chemostats with natural marine bacteria populations. *Aquatic Microbial Ecology* 38:125–133.
- Cebri n, J. 1999. Patterns in the fate of production in plant communities. *American Naturalist* 154:449–468.
- Celar, F. 2003. Competition for ammonium and nitrate forms of nitrogen between some phytopathogenic and antagonistic soil fungi. *Biological Control* 28:19–24.
- Currie, D. J., and J. Kalf . 1984. A comparison of the abilities of freshwater algae and bacteria to acquire and retain phosphorus. *Limnology and Oceanography* 29:298–310.
- Daufresne, T., and M. Loreau. 2001a. Ecological stoichiometry, primary producer-decomposer interactions and ecosystem persistence. *Ecology* 82:3069–3082.
- . 2001b. Plant-herbivore interactions and ecological stoichiometry: when do herbivores determine plant nutrient limitation? *Ecology Letters* 4:196–206.
- del Giorgio, P. A., and J. J. Cole. 1998. Bacterial growth efficiency in natural aquatic systems. *Annual Review of Ecology and Systematics* 29:503–541.
- Diedhiou, A. G., F. Verpillot, O. Gueye, B. Dreyfus, R. Duponnois, and A. M. Ba. 2004. Do concentrations of glucose and fungal inoculum influence the competitiveness of two early-stage ectomycorrhizal fungi in *Azelia africana* seedlings? *Forest Ecology and Management* 203:187–194.
- Eiland, F., M. Klamer, A.-M. Lind, M. Leth, and E. B  ath. 2001. Influence of initial C/N ratio on chemical and microbial composition during long term composting of straw. *Microbial Ecology* 41:272–280.
- Eiler, A., S. Langenheder, S. Bertilsson, and L. J. Tranvik. 2003. Heterotrophic bacterial growth efficiency and community structure at different natural organic carbon concentrations. *Applied and Environmental Microbiology* 69:3701–3709.
- Evans-White, M. A., R. S. Stelzer, and G. A. Lamberti. 2005. Taxonomic and regional patterns in benthic macroinvertebrate elemental composition in streams. *Freshwater Biology* 50:1786–1799.
- Goldman, J. C., and M. R. Dennett. 1991. Ammonium regeneration and carbon utilization by marine bacteria grown on mixed substrates. *Marine Biology* 109:369–378.
- . 2000. Growth of marine bacteria in batch and continuous culture under carbon and nitrogen limitation. *Limnology and Oceanography* 45:789–800.
- Grover, J. P. 2002. Stoichiometry, herbivory and competition for nutrients: simple models based on planktonic ecosystems. *Journal of Theoretical Biology* 214:599–618.
- Hall, S. R. 2004. Stoichiometrically explicit competition between grazers: species coexistence, replacement, and priority effects along resource supply gradients. *American Naturalist* 164:157–172.
- Herbert, D. 1976. Stoichiometric aspects of microbial growth. Pages 1–30 in A. C. R. Dean, D. C. Ellwood, C. G. T. Evans, and J. Melling, eds. *Continuous culture*. Vol. 6. Application and new fields. Horwood, Chichester.
- Jansson, M., A. K. Bergstr m, D. Lymer, K. Vrede, and J. Karlsson. 2006. Bacterioplankton growth and nutrient use efficiencies under variable organic carbon and inorganic phosphorus ratios. *Microbial Ecology* 52:358–364.
- Leckie, S. E. 2005. Methods of microbial community profiling and their application to forest soils. *Forest Ecology and Management* 220:88–106.
- Lennon, J. T., and L. E. Pfaff. 2005. Source and supply of terrestrial organic matter affects aquatic microbial metabolism. *Aquatic Microbial Ecology* 39:107–119.
- Loladze, I., Y. Kuang, J. J. Elser, and W. F. Fagan. 2004. Coexistence of two predators on one prey mediated by stoichiometry. *Theoretical Population Biology* 65:1–15.
- MacArthur, R. H. 1972. *Geographical ecology*. Harper & Row, New York.
- Makino, W., J. B. Cotner, R. W. Sterner, and J. J. Elser. 2003. Are bacteria more like animals than plants? growth rate and resource dependence of bacterial C : N : P stoichiometry. *Functional Ecology* 17:121–130.
- Marr, A. G., E. H. Nilson, and D. J. Clark. 1962. The maintenance requirement of *Escherichia coli*. *Annals of the New York Academy of Sciences* 102:536–548.

- Miller, T. E., J. H. Burns, P. Munguia, E. L. Walters, J. M. Kneitel, P. M. Richards, N. Mouquet, and H. L. Buckley. 2005. A critical review of twenty years' use of the resource-ratio theory. *American Naturalist* 165:439–448.
- Mindl, B., B. Sonntag, J. Pernthaler, J. Vrba, R. Psenner, and T. Posch. 2005. Effects of phosphorus loading on interactions of algae and bacteria: reinvestigation of the "phytoplankton-bacteria paradox" in a continuous cultivation system. *Aquatic Microbial Ecology* 38: 203–213.
- Parnas, H. 1975. Model for decomposition of organic material by microorganisms. *Soil Biology and Biochemistry* 7:161–169.
- Smith, V. H. 1993. Applicability of resource-ratio theory to microbial ecology. *Limnology and Oceanography* 38:239–249.
- Sterner, R. W., and J. J. Elser. 2002. Ecological stoichiometry: the biology of elements from molecules to the biosphere. Princeton University Press, Princeton, NJ.
- Thingstad, T. F. 1987. Utilization of N, P, and organic C by heterotrophic bacteria. I. Outline of a chemostat theory with a consistent concept of "maintenance" metabolism. *Marine Ecology Progress Series* 35:99–109.
- Thingstad, T. F., and B. Pengerud. 1985. Fate and effect of allochthonous organic material in aquatic microbial ecosystems: an analysis based on chemostat theory. *Marine Ecology Progress Series* 21:47–62.
- Tiedje, J. M., S. Asuming-Brempong, K. Nüsslein, T. L. Marsh, and S. J. Flynn. 1999. Opening the black box of soil microbial diversity. *Applied Soil Ecology* 13:109–122.
- Tilman, D. 1980. Resources: a graphical mechanistic approach to competition and predation. *American Naturalist* 116:362–393.
- . 1981. Tests of resource competition theory using four species of Lake Michigan algae. *Ecology* 62:802–815.
- . 1986. A consumer-resource approach to community structure. *American Zoologist* 26:5–22.
- Touratier, F., L. Legendre, and A. Vézina. 1999. Model of bacterial growth influenced by substrate C : N ratio and concentration. *Aquatic Microbial Ecology* 19:105–118.
- Vadstein, O. 1998. Evaluation of competitive ability of two heterotrophic planktonic bacteria under phosphorus limitation. *Aquatic Microbial Ecology* 14:119–127.
- Vallino, J., C. Hopkinson, and J. Hobbie. 1996. Modeling bacterial utilization of dissolved organic matter: optimization replaces Monod growth kinetics. *Limnology and Oceanography* 41:1591–1609.
- Vrede, K., M. Heldal, S. Norland, and G. Bratbak. 2002. Elemental composition (C, N, P) and cell volume of exponentially growing and nutrient-limited bacterioplankton. *Applied and Environmental Microbiology* 68:2965–2971.
- Vrede, T., D. R. Dobberfuhl, S. A. L. M. Kooijman, and J. J. Elser. 2004. Fundamental connections among organism C : N : P stoichiometry, macromolecular composition, and growth. *Ecology* 85: 1217–1229.
- Zinn, M., B. Witholt, and T. Egli. 2004. Dual nutrient limited growth: models, experimental observations, and applications. *Journal of Biotechnology* 113:263–279.

Associate Editor: William F. Fagan
 Editor: Donald L. DeAngelis